

(2) #2-64 MTG. HLS.

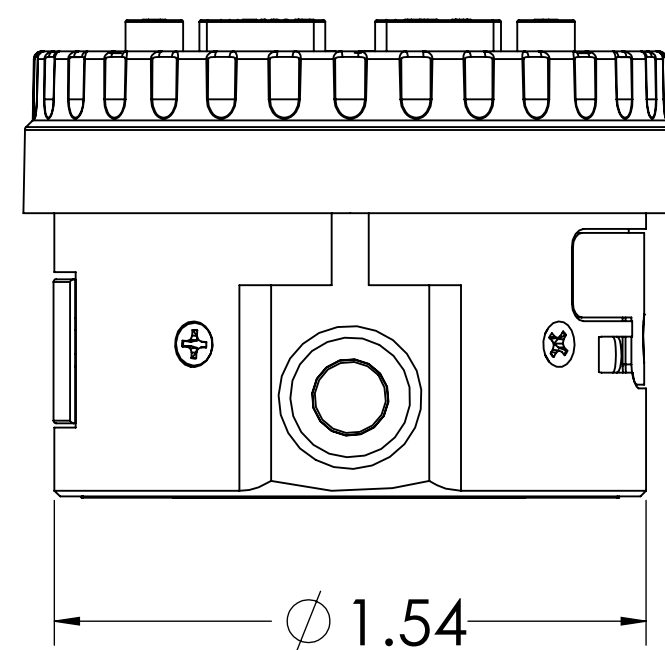

MQ4665  
 TRAVEL:  $.40''$   
 RESOLUTION:  $.0005''/.01\text{mm}$